

North Shore Amateur Radio Club

IRLP & OTHER VoIP MODES

Presented by Barrie Skeldon. VE7HBS/VA7BS

May 2008

North Shore Amateur Radio Club

- * VOIP - VOICE OVER INTERNET PROTOCOL

- * AMATEUR RADIO AND THE COMPUTER

- INTERNET RADIO LINKING PROJECT

- ECHOLINK & EQSO

VoIP AND HAM RADIO

IRLP - RADIO ONLY

ECHOLINK - COMPUTER ONLY + RADIO

EQSO – COMPUTER ONLY + RADIO

North Shore Amateur Radio Club

IRLP – RADIO ONLY

SINGLE USER MODE – Does not require a computer!

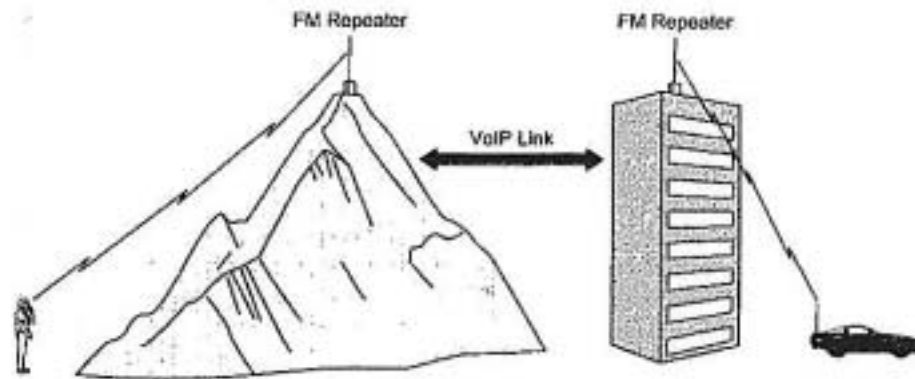

IRLP Node – Requires Computer

North Shore Amateur Radio Club

- Two Modes - Direct Connection-One to One
 - Reflector – One to Many

Direct Connection - City to City Chat

- Two Nodes Connected
- No Other IRLP Conns Possible
- Currently connected to Callsign
- All Local Traffic Heard on Both

North Shore Amateur Radio Club

Reflector Connection

- Computer sitting on lots of bandwidth
- Not connected to any radio
- Many Repeaters inter-connected
- Check on <http://status.irlp.net>

North Shore Amateur Radio Club

- **IRLP OPERATING PROCEDURES – Direct Connection**
- Locate repeater with IRLP access – Locally 444.95, 441.975 & 145.27Mhz
- Determine the IRLP node or reflector number to called from listing on Internet – www.irlp.net
Listen to chosen repeater for 15 secs then ask “Is repeater in use”
- If clear, PTT wait 2 secs then give your callsign , name and number of node you wish to call then with DTMF tones and enter node number to be called. Pause for 2 secs and release PTT.
- The called node will confirm connection with number and location.
- If node is currently connected!!

North Shore Amateur Radio Club

IRLP – Direct Connection

- Wait at least 15 secs before announcing your call and intention.
- Call for specific callsign or ask for general CQ
- Always handy to include your QTH and name.
- If no response announce your call and intent to drop the link
- Enter DTMF OFF code “73”
- No Activity?

North Shore Amateur Radio Club

IRLP OPERATING PROCEDURE – Reflector connection

Locate IRLP repeater to be used, listen for 15 secs then ask “if in use”.

If clear, PTT and pause 2 secs before giving your callsign and name and number of Reflector to be called then use DTMF tones to enter node number and pause for 2 secs before unkeying.

Reflector will announce if and when connected

Pause for at least 15 secs before identifying yourself (callsign) and give your city/province/country. With worldwide coverage it is best to detail your QTH

North Shore Amateur Radio Club

IRLP – Reflector Connection

Do not be in a hurry to hear a comeback, keep announcing your monitoring on a regular basis

If the QSO appears to be a long one move off the reflector to a direct node

Do not rag chew on local repeater while connected to Reflector.

Do pause between transmissions to let others in or enter DTMF command.

After QSO or monitoring, to drop link announce callsign and intention to drop then enter with DTMF tone “73”. Reflector will announce the drop.

Remember the three main rules, 1-pause, 2-pause, 3-pause.

North Shore Amateur Radio Club

Google Earth and IRLP Interactive Node Mapping

Download special program from www.irlp.net
and install.

Shows connected Reflectors and Nodes



IRLP - Internet Radio Linking Project - Mozilla Firefox

File Edit View History Bookmarks Tools Help

http://www.irlp.net/ Search

Getting Started Latest Headlines

Home Page
Introduction
How it Works
FAQ
IRLP Guidelines
Owners FAQ
NODE RADIOS
NODE INFO
Embedded
NEW Nodes NEW
Order IRLP
Update DB info
Donations
Email Lists
IRLP Stories
Related Links
Questions??
IRLP Net Info
In The News
Credits



IRLP

Interactive World Node Mapping

IRLP - Keeping the Radio in Amateur Radio

We have some more cool stuff happening on the Google Earth front:

1. Update your [google earth client](#) to the latest BETA version
2. Click this link: <http://www.irlp.net/setup-irlp.kml>

It will download a "network linked" kmz file from the server which will update every 2 minutes, complete with all the info for all the links and nodes.

Soon we will split the Active nodes, down nodes, and links out into separate "Network Links".

When existing Google Earth, when prompted, save the changes. That way all you will have to do is open up Google Earth, and all IRLP connections will be displayed. Yellow lines are node to node while blue are reflector connections.

The process producing this KML routine was originally created by David McAnally KF7FLY and Dave Cameron VE7LTD.

Enjoy IRLP and please "Pass the Word"
If left menu bar is not visible, [click here](#)
last updated February 14, 2007
◆ 2005 IRLP.NET
[Privacy Policy](#)

[Go Back](#) [Print this Page](#)

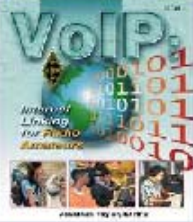

Done

start IRLP - Internet Radio... 2:42 PM

Search

Fly To Find Businesses Directions

Fly to e.g., New York, NY

Search input field with magnifying glass icon

Places

Add Content

- IRLP Active Node List
 - >Click here now for important information
 - Notice: Please do not configure your Google IRLP Active Nodes Wed, 04 Jun 2008 16:08:01 -0600
 - Antigua & Barbuda
 - Aruba
 - Australia

Layers

View: Core

- Primary Database
- Geographic Web
- Roads
- 3D Buildings
- Borders and Labels
- Traffic

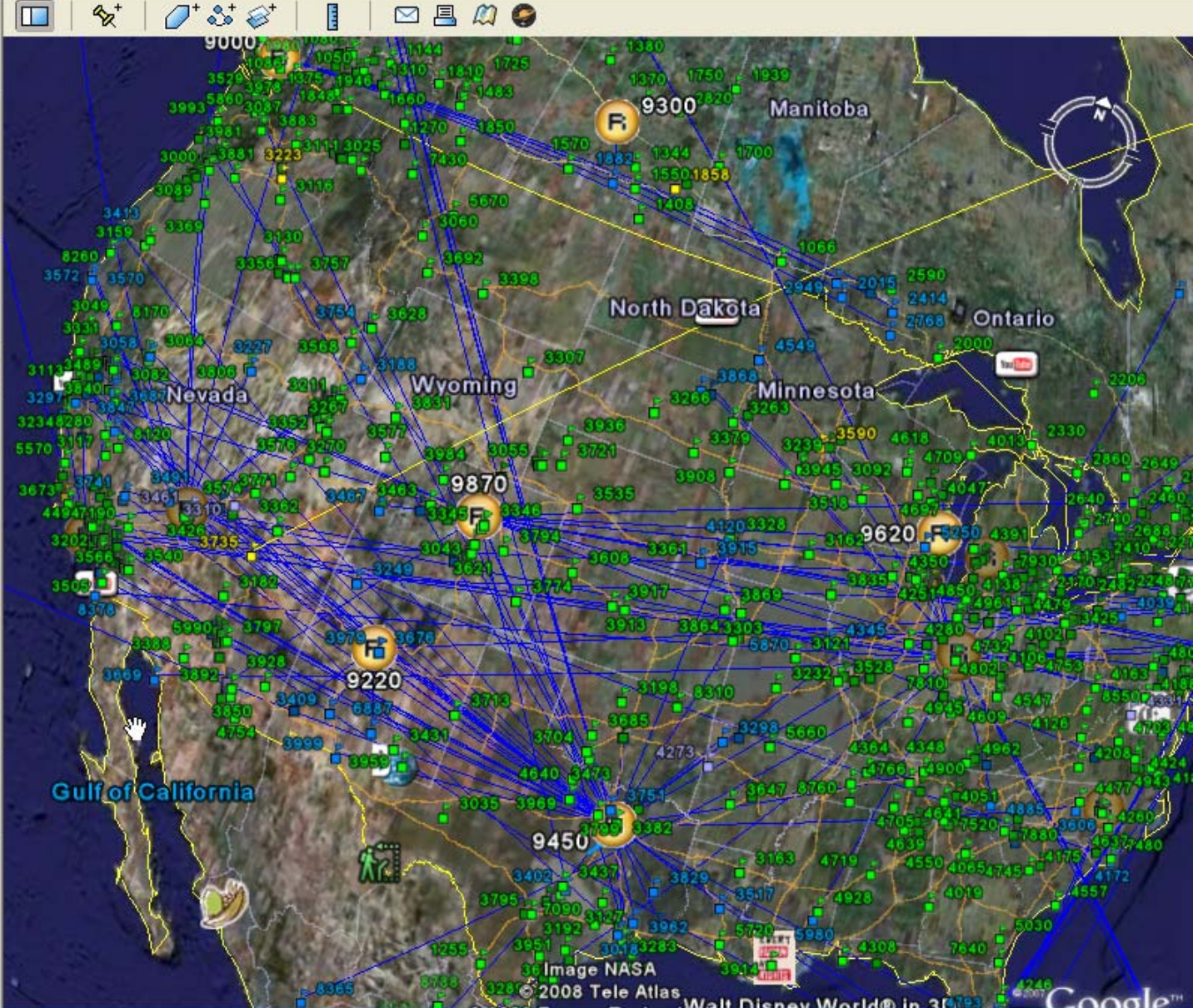

North Shore Amateur Radio Club

ECHOLINK & EQSO - Requires a computer

Linking Example

SYSOP

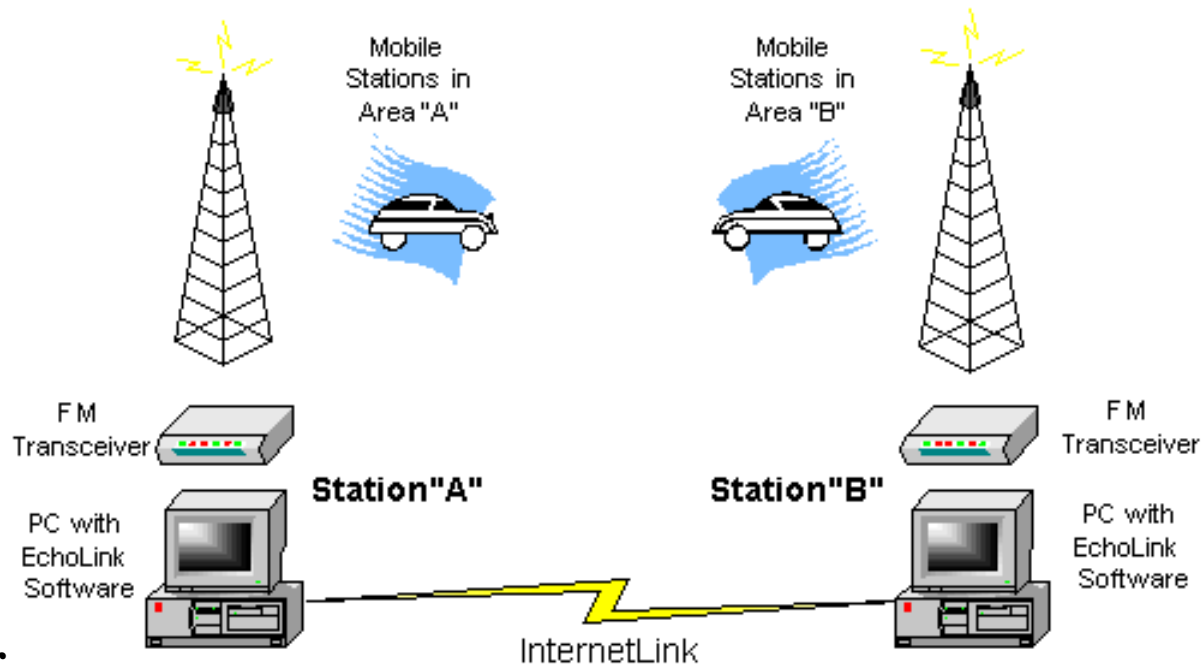

Single User

ECHOLINK & eQSO OPERATING MODES

1. - SINGLE USER

2. - SYSOP (System Operator)

* LINKED

* REPEATER

**HARDWARE REQUIREMENTS for
Echolink & eQSO**

Single User - Computer to Computer

PC Running Windows 98/2000/XP

Sound Card

PC Microphone

Internet Modem (Dial or Cable)

**HARDWARE REQUIREMENTS for Echolink
& eQSO**

Sysop - Transceiver to Computer

PC Running Windows 98/2000/XP

Sound Card & PC Microphone

Sound Card Interface (Rigblaster, MFJ, WB2REM, VA3TO)

Internet Modem (Dial or Cable)

Transceiver

Connecting Cables

Typical station hookup diagram

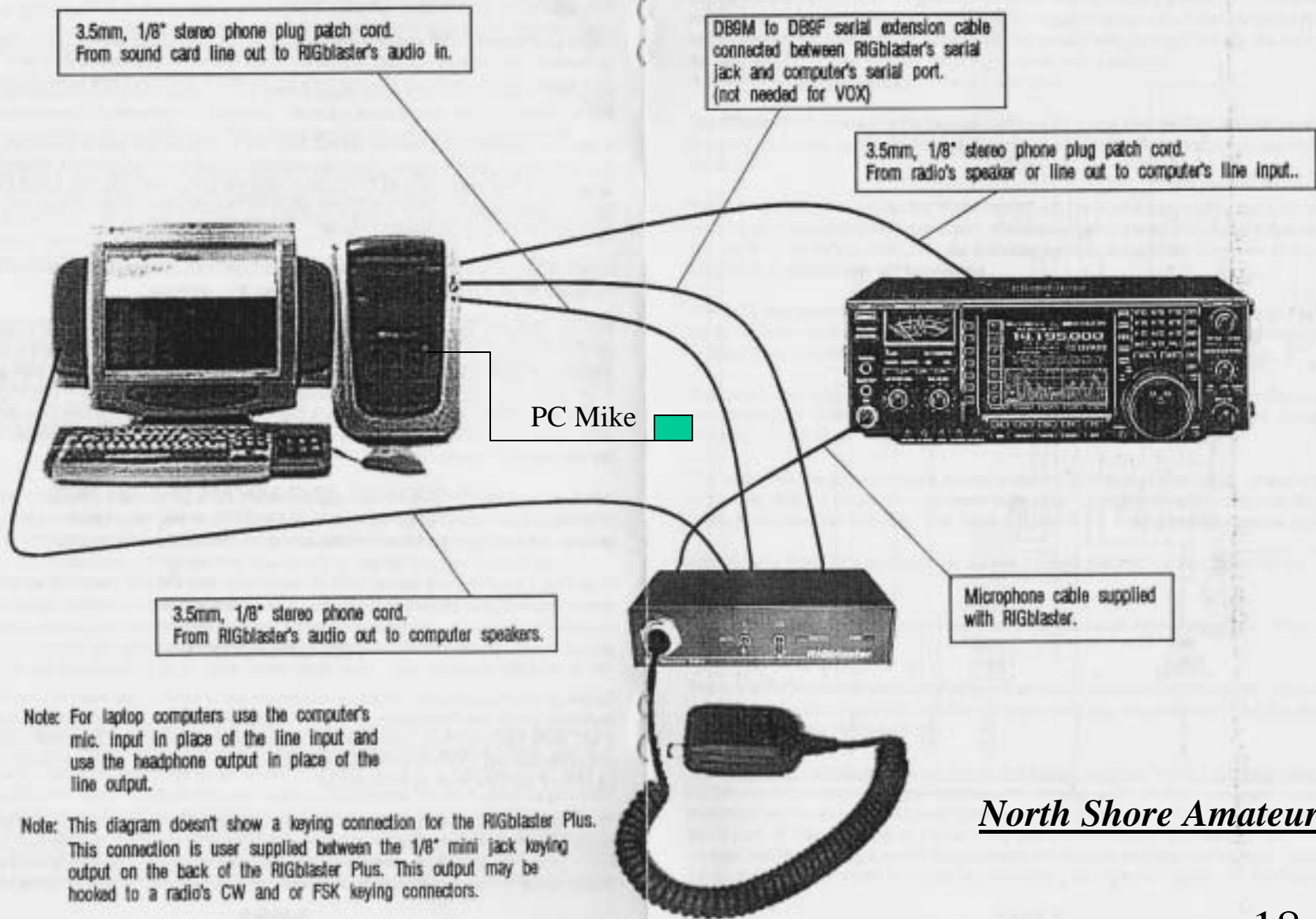

North Shore Amateur Radio
Club

North Shore Amateur Radio Club

LINKED RADIO SETUP

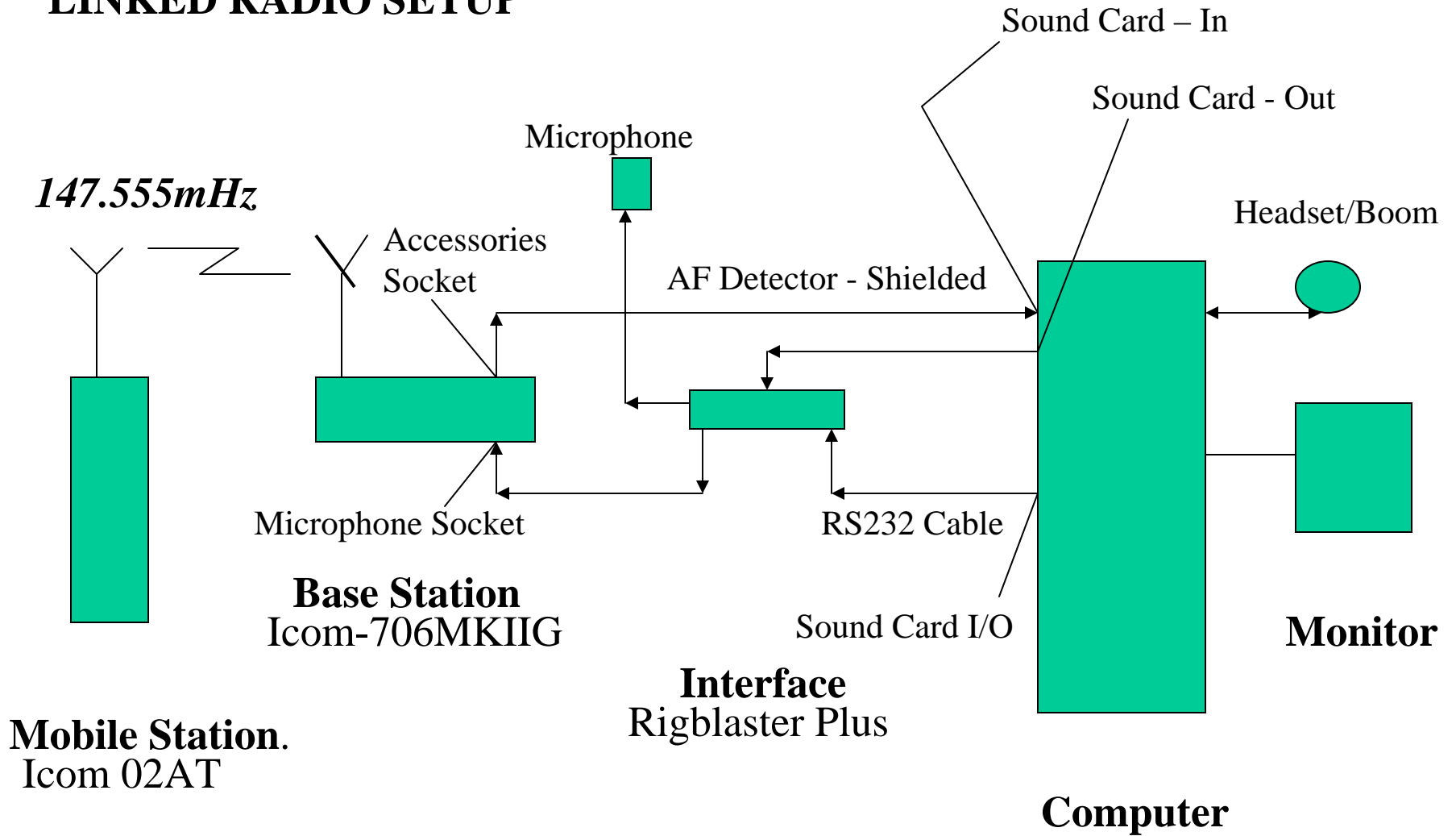

OPERATING

Single User – Computer to Computer

Download Software and Install – www.echolink.org

Callsign Validation - www.eQSO.org

READ THE HELP FILE

Connect PC Microphone to Sound Card

Using System setup

Using Preferences

Using Echotest Conference to set Vol/Record Levels

Ready to Call out



3,879 stations on nawest.echolink.org (18% are busy)

Station	Stat	Time	Location	Node
DUTCH	On	04:03	Dutch Conference [0/12]	107339
DX-PINOY	On	19:02	Filipino Conference [3/50]	350661
DX1ARM	On	19:02	Quezon City, Phils. [3/20]	298306
DX1EVM	On	19:02	DILIMAN Q.C. Philip [10/15]	122543
DX2IL	On	11:03	-((www.dx2il.tk))- [4/100]	337623
EA1SPAIN	On	04:03	Lugo_Spain [8/15]	352223
EA8SPAIN	On	03:03	Islas Canarias_Spain [4/15]	347979
ECHIGO	On	11:03	Niigata-Net Japan [2/599]	365211
ECHOTEST	On	02:03	Audio test server	9999
ECHOTHAI	On	19:02	T H A I L A N D (ä · â) [5]	257962
ENGLAND	On	04:03	United Kingdom (UK) [0/200]	7889
ERASPAIN	On	04:03	E.R.A Emergencias Sp [0/20]	361422
ERC-ECS	On	19:02	"LDS ERC-ECS Nets o [0/500]	328327
ESPANA	On	04:03	Conferencia Latina [11/500]	6954
ESPANA2	On	04:03	Conferencia Latina [2/500]	3160
FINLINK	On	05:03	Finland [0/25]	83417
FLORIDA	On	22:02	Ontario Morning Gang 8 [1]	1842
FRACOL	On	22:02	FRACOL Digital Link [1/100]	265774
FREE-DX	On	20:02	Filipino Hams Canada [5/20]	55736
GAUCHO	On	23:02	Conferência Gaúcho. [3/25]	264407
GERMANY	On	04:03	Nuernberg Univ. [0/100]	71982
GSARC	On	19:02	Northern California [1/15]	46989
HAKODATE	On	11:03	HAKODATE, Japan. [4/20]	311176
HAMFESAM	On	11:03	AM rollcall group. [1]	338280
HAMSHACK	On	19:02	Pacifica, CA,U.S.A. [5/50]	297680
HAMTHAI	On	09:03	hamthailand.com [24/200]	267491

CONF Audio test server [3]
 VE7HBS-L Robert
 This test server simply records and plays back transmissions for testing purposes. Use it all you like.

Index View Explorer View

Connected to: *ECHOTEST* (Conference [2]) CONF

Host: ip-68-178-202-110.ip.secureserver.net

TX

Send



3,866 stations on nawest.echolink.org (19% are busy)

Station	Stat	Time	Location	Node
VE6CZR-L	Busy	20:56	Edmonton Ab.canada	232033
VE6DBD-L	Busy	20:54	Edmonton	5972
VE6DNY-L	Busy	20:59	calgary	110491
VE6MV-L	On	21:01	Calgary, CA N A D A	94113
VE6OG-L	On	20:55	Edmonton (146.49 MHz (1))	83835
VE6RPA-L	Busy	20:53	Edmonton,alberta,canada	28617
VE6SMN-L	Busy	20:59	Edmonton Ab Canada	352399
VE7BA5-L	On	19:02	In Conference IRLP 1269	69477
VE7EDA-L	On	19:02	EchoIRLP New Denver, BC	153549
VE7HBS-L	On	20:01	North Vancouver,BC, Can	181381
VE7HFY-L	On	19:59	Smithers,B.C.	187791
VE7HKW-L	On	19:59	Vancouver, burnaby	53191
VE7JPS-L	On	13:05	boyle alberta	383058
VE7LEL-L	On	20:00	Nelson B.C. Canada	4793
VE7MDT-L	On	19:59	In Conference *SEAGATE*	166494
VE7MTY-L	On	19:02	EchoIRLP Pitt Meadows, BC	44463
VE7TMQ-L	On	19:02	Chilliwack, BC	343716
VE7WCC-L	On	19:58	NewWestminster B.C	243320
VE7WNE-L	On	20:00	Quesnel B.C. 146.560	65192
VE7XL-L	Busy	19:59	In Conference *RATS-BC*	221815
VE9MMB-L	On	00:00	Shediac N.B 146.550	39542
VK2AFC-L	Busy	12:57	vk2afc.weebly.com	244270
VK2BGL-L	On	13:03	In Conference VK2BGL-R	1484
VK2BLO-L	On	12:56	In Conference VK2HJB-L	270506
VK2CPR-L	On	13:00	Albury 144.650 (1)	264395
VK2DDD-L	On	12:03	Newcastle	356838

 Index View
 Explorer View

Station VE7HBS-L

 Robert
 North Vancouver,BC, Can

 Connected to: VE7HBS-L Robert
 Canada

Host: S010600e07da93751.vn.shawcable.net

TX

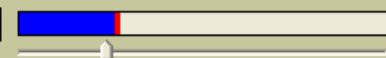

Send

OPERATING

SYSOP - LINKED (Radio to Computer)

Download Software and Install

Callsign Validation – L Suffix

READ HELP FILE

Connect Interface

Choose a Simplex Operating Frequency

Using Set-up

Using Preferences

Using Sysop Settings

Using Link Wizard

North Shore Amateur Radio Club

CALL OUT OPTIONS

- * On IRLP - Single Nodes & Reflectors

- On Echolink
 Repeaters/Links/Callsigns/Conferences

- * On eQSO - Rooms

eQSO - DTMF RF Gateway

MB7IBR-L Bromley Kent, 144.825, 50.540, 70.4125, 1299.850, Echolink 430.1625 & 29.530
 MB7IBS-L Bristol Gateway 431.150MHz PL 118.8Hz DTMF
 MB7ICK-L ..2E1EHM-City of Canterbury 145.3375 ctcss 103.5
 MB7IEX-L Exmouth, Devon UK - 50.540 Mhz - 107.2 Hz - Ctcss - m0agi@btinternet.com
 MB7INE-L Jarow Tyneside, UK,ctcss 118.8
 MB7IOP-L Isle of Portland uk, 145.2125 MHz 71.9 Hz Phil@dt5.co.uk
 MB7ISC-L The Scotch Corner Gateway 145.3375MHz CTCSS 88.5Hz Estd. June 2001
 MB7IUR-L East Midlands, UK.....www.m1gur.co.uk.....d(-_)b
 MB7IWB-L 2 metre link 145.3375 wickham bishops mid essex jo01 is email: david.sampson@
 MB7IWW-L West Wales. Please email andy@gw6jso.info if this link causes problems
 VE3SNE-L Sault Ste. Marie, Ont., Canada 147.450 053.450 & 444.475 Duplex PL 100.0
 VE7GCE-L -- Ray -- North Vancouver Island - British Columbia - Canada
 VE7HBS-L North Vancouver, BC Canada

Connection: Presets [dropdown] Edit...
 Server: server.eqso.net Port: 10024 Register
 Server Password: [input] Help Connect
 Room: 101ENGLISH See Who's on the system Disconnect

Callsign / Comment: VE7HBS-L North Vancouver, BC Canada Send

Speed (WPM): 18 Courtesy CW: K [checkbox] Courtesy Tones
 Frequency (Hz): 650 ID CW: [input] [checkbox] ID if Idle
 Volume 0-32000: 5000 [checkbox] Force ID Enabled Apply

CW/Voice Announcements: Setup RF Announcements... Next Tick (1) in 7 s [checkbox] DTMF On
 DTMF DECODE Auto Return On Off OFF DTMF Help

RF Gateway settings:
 Line In PTT
 Line Vox Vu Vol Output Vu Vol
 Silence Level [slider]
 Dial-up to Internet on Connect
 Auto-Reconnect
 Mute ALC
 Squelch Settling (ms) 2000 Rig Keying... [button]
 Connect Code 12
 Disconnect Code 21
 DTMF [sliders]

eQSO System monitor by MOZPD

Connect To Selected Room Refresh 15 Min Refresh

The Tree view of Servers, Rooms, and, Users will refresh once

- server.eqso.net Your Donation to eQSO will make a difference
 - OLD FOLKS
 - W6SCS-L SANTA CLARITA SENIOR RADIO CLUB
 - *AESPANA*
 - W2NQS-R *Benvenuto a * ESPANA* &*444.675*
 - *AIESM*
 - W2NQS-L *Welcome to**MIAMI**ITESM**MID-F
 - 101ENGLISH
 - ZW0SKW-L Cwmllynfell link using 144.825 Mhz no
 - G0WYGG-L Bromley Kent, 144.825, 50.540, 70.412
 - M1DOZ-L essex link on 430.0125 J0011S Great T
 - MB7IBR-L Bromley Kent, 144.825, 50.540, 70.412
 - MB7IBS-L Bristol Gateway 431.150MHz PL 118.8
 - MB7ICK-L ..2E1EHM-City of Canterbury 145.3375
 - MB7IEX-L Exmouth, Devon UK - 50.540 Mhz - 107
 - MB7INE-L Jarow Tyneside, UK,ctcss 118.8
 - MB7IOP-L Isle of Portland uk, 145.2125 MHz 71.9
 - MB7ISC-L The Scotch Corner Gateway 145.3375M
 - MB7IUR-L East Midlands, UK.....www.m1gur
 - MB7IWB-L 2 metre link 145.3375 wickham bishop
 - MB7IWW-L West Wales. Please email andy@gw6j
 - VE3SNE-L Sault Ste. Marie, Ont., Canada 147.45
 - VE7GCE-L -- Ray -- North Vancouver Island - Bri
 - VE7HBS-L North Vancouver, BC Canada
 - 1USGateway
 - WB9EIU-R Gateway to CQ100 EchoLink eQSO 1
 - 6 meters
 - N3QZU-R ACME, PA. USA.
 - AUDIO TEST
 - AUDIO TEST This Is The Audio Test Room ... Spe
 - BOGOTA
 - HK3RD-R Liga Radio Bogotá <- 145.490- Cerro C
 - UY0NQU-R LICAPADIO PACTO Link con la PBT

North Shore Amateur Radio Club

SYSOP - LINK

REGISTER LINK FREQUENCY

British Columbia Amateur Radio Coordination Council
(BCARCC)

Suggested Simplex Frequency Range

147.570 to 147.420 MHz

In 15kHz steps down from upper frequency

Echolink Trouble Shooter Software

Book from ARRL

- VoIP – Internet Linking for Radio Amateurs